

Milton Lecture Theatre

Contact Details	Phone	email
Security Emergency number General enquiries	3333 2599	whitechapel-security@qmul.ac.uk
Audio Visual / Lecture Capture Technical assistance/faults Audio visual bookings	6550 8164	its-helpdesk@qmul.ac.uk avbookings@qmul.ac.uk
Maintenance / Cleaning / Porters	2580	estates-helpdesk@qmul.ac.uk
Room Bookings Room booking enquiries Events & Hospitality sales office	8163 8174	timetabling@qmul.ac.uk https://WebRoomBookings.qmul.ac.uk enquiries@qmhospitality.co.uk



Please note that the external prefix to all these numbers is 020-7882

The fire evacuation meeting point for this building is
Blizard Mews, Newark Street

Room Details	Capacity - 120 (fixed)
General Equipment	120 Fixed Seats, Teaching Desk
Audio Visual Equipment	Data Projector, VHS, DVD, PA, PC, Visualiser, 2 Screens, Whiteboard, Lecture Capture

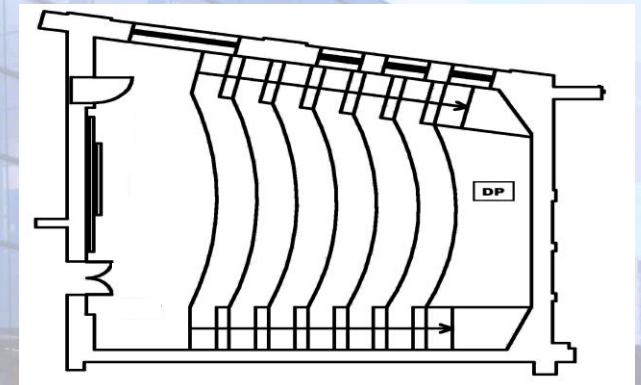

No food and drink. Please replace furniture.

G.18

Contact Details	Phone	email
Security Emergency number General enquiries	3333 2599	whitechapel-security@qmul.ac.uk
Audio Visual / Lecture Capture Technical assistance/faults Audio visual bookings	6550 8164	lts-helpdesk@qmul.ac.uk avbookings@qmul.ac.uk
Maintenance / Cleaning / Porters	2580	estates-helpdesk@qmul.ac.uk
Room Bookings Room booking enquiries Events & Hospitality sales office	8163 8174	timetabling@qmul.ac.uk https://WebRoomBookings.qmul.ac.uk enquiries@qmhospitality.co.uk

Please note that the external prefix to all these numbers is 020-7882

The fire evacuation meeting point for this building is
Blizard Mews, Newark Street

Room Details	Capacity - 84 (fixed)
General Equipment	84 Student PC Stations, Master PC, 2 Print Servers, 3 Printers
Audio Visual Equipment	3 Data Projectors, LCD Screen, VHS, PA, 3 Screens

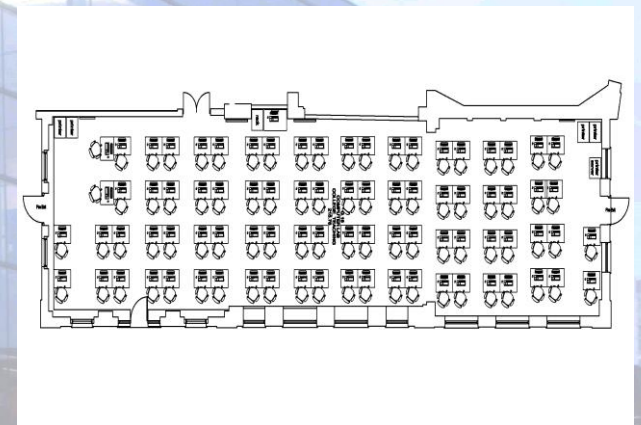

No food and drink. Please replace furniture.

1.21

Contact Details	Phone	email
Security Emergency number General enquiries	3333 2599	whitechapel-security@qmul.ac.uk
Audio Visual / Lecture Capture Technical assistance/faults Audio visual bookings	6550 8164	lts-helpdesk@qmul.ac.uk avbookings@qmul.ac.uk
Maintenance / Cleaning / Porters	2580	estates-helpdesk@qmul.ac.uk
Room Bookings Room booking enquiries Events & Hospitality sales office	8163 8174	timetabling@qmul.ac.uk https://WebRoomBookings.qmul.ac.uk enquiries@qmhospitality.co.uk



Please note that the external prefix to all these numbers is 020-7882

The fire evacuation meeting point for this building is **Blizard Mews, Newark Street**

Room Details	Capacity - 40
General Equipment	40 Tables, 40 Chairs, Teaching Desk
Audio Visual Equipment	Data Projector, VHS, DVD, PA, PC, Screen, Whiteboard, Lecture Capture

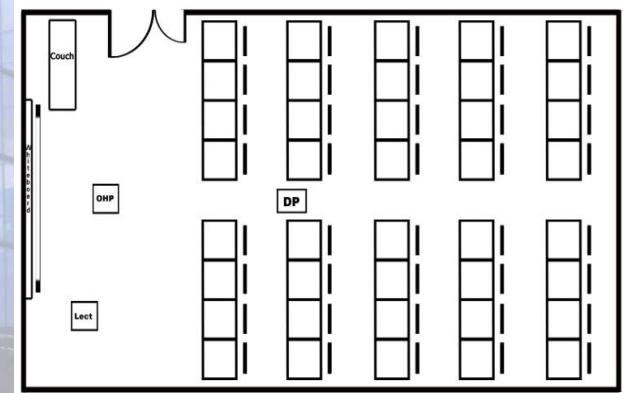

No food and drink. Please replace furniture.

1.23

Contact Details	Phone	email
Security Emergency number General enquiries	3333 2599	whitechapel-security@qmul.ac.uk
Audio Visual / Lecture Capture Technical assistance/faults Audio visual bookings	6550 8164	its-helpdesk@qmul.ac.uk avbookings@qmul.ac.uk
Maintenance / Cleaning / Porters	2580	estates-helpdesk@qmul.ac.uk
Room Bookings Room booking enquiries Events & Hospitality sales office	8163 8174	timetabling@qmul.ac.uk https://WebRoomBookings.qmul.ac.uk enquiries@qmhospitality.co.uk



Please note that the external prefix to all these numbers is 020-7882

The fire evacuation meeting point for this building is
Blizard Mews, Newark Street

Room Details	Capacity – 12
General Equipment	2 Large Tables, 12 Chairs
Audio Visual Equipment	LCD Screen, Whiteboard

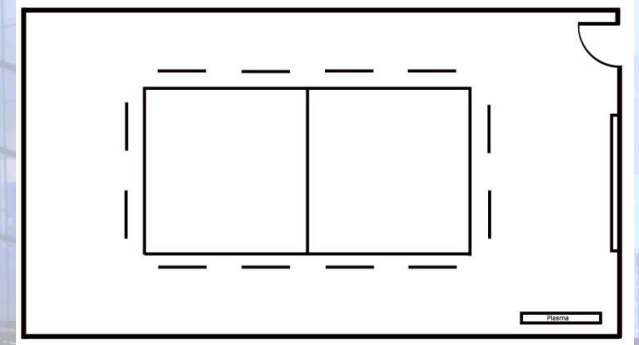

No food and drink. Please replace furniture.

1.26

Contact Details	Phone	email
Security Emergency number General enquiries	3333 2599	whitechapel-security@qmul.ac.uk
Audio Visual / Lecture Capture Technical assistance/faults Audio visual bookings	6550 8164	lts-helpdesk@qmul.ac.uk avbookings@qmul.ac.uk
Maintenance / Cleaning / Porters	2580	estates-helpdesk@qmul.ac.uk
Room Bookings Room booking enquiries Events & Hospitality sales office	8163 8174	timetabling@qmul.ac.uk https://WebRoomBookings.qmul.ac.uk enquiries@qmhospitality.co.uk



Please note that the external prefix to all these numbers is 020-7882

The fire evacuation meeting point for this building is
Blizard Mews, Newark Street

Room Details	Capacity - 12
General Equipment	10 Tables, 12 Chairs
Audio Visual Equipment	LCD Screen, PC, Whiteboard

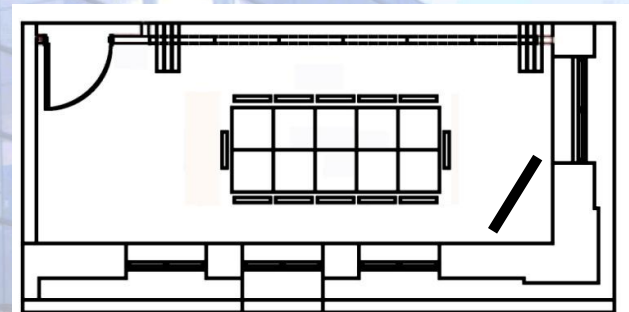

No food and drink. Please replace furniture.

1.26A

Contact Details	Phone	email
Security Emergency number General enquiries	3333 2599	whitechapel-security@qmul.ac.uk
Audio Visual / Lecture Capture Technical assistance/faults Audio visual bookings	6550 8164	its-helpdesk@qmul.ac.uk avbookings@qmul.ac.uk
Maintenance / Cleaning / Porters	2580	estates-helpdesk@qmul.ac.uk
Room Bookings Room booking enquiries Events & Hospitality sales office	8163 8174	timetabling@qmul.ac.uk https://WebRoomBookings.qmul.ac.uk enquiries@qmhospitality.co.uk



Please note that the external prefix to all these numbers is 020-7882

The fire evacuation meeting point for this building is
Blizard Mews, Newark Street

Room Details	Capacity - 10
General Equipment	8 Tables, 10 Chairs
Audio Visual Equipment	LCD Screen, PC, Data Projector (when room open), Screen, Whiteboard

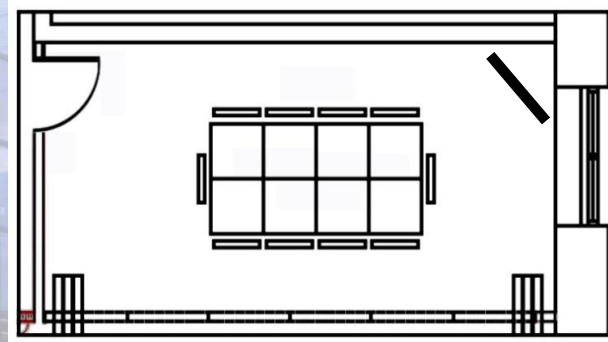

No food and drink. Please replace furniture.

1.27

Contact Details	Phone	email
Security Emergency number General enquiries	3333 2599	whitechapel-security@qmul.ac.uk
Audio Visual / Lecture Capture Technical assistance/faults Audio visual bookings	6550 8164	its-helpdesk@qmul.ac.uk avbookings@qmul.ac.uk
Maintenance / Cleaning / Porters	2580	estates-helpdesk@qmul.ac.uk
Room Bookings Room booking enquiries Events & Hospitality sales office	8163 8174	timetabling@qmul.ac.uk https://WebRoomBookings.qmul.ac.uk enquiries@qmhospitality.co.uk



Please note that the external prefix to all these numbers is 020-7882

The fire evacuation meeting point for this building is
Blizard Mews, Newark Street

Room Details	Capacity - 10
General Equipment	10 Tables, 10 Chairs
Audio Visual Equipment	LCD Screen, Resident PC, Whiteboard

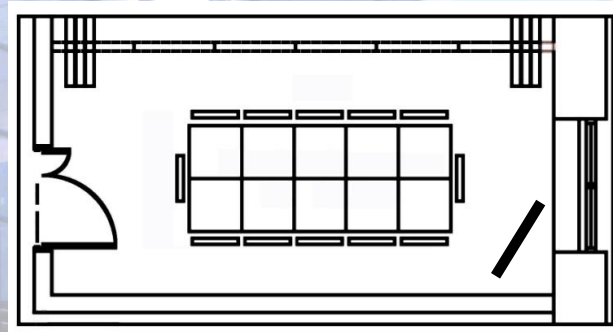

No food and drink. Please replace furniture.

1.27A

Contact Details	Phone	email
Security Emergency number General enquiries	3333 2599	whitechapel-security@qmul.ac.uk
Audio Visual / Lecture Capture Technical assistance/faults Audio visual bookings	6550 8164	lts-helpdesk@qmul.ac.uk avbookings@qmul.ac.uk
Maintenance / Cleaning / Porters	2580	estates-helpdesk@qmul.ac.uk
Room Bookings Room booking enquiries Events & Hospitality sales office	8163 8174	timetabling@qmul.ac.uk https://WebRoomBookings.qmul.ac.uk enquiries@qmhospitality.co.uk



Please note that the external prefix to all these numbers is 020-7882

The fire evacuation meeting point for this building is
Blizard Mews, Newark Street

Room Details	Capacity - 10
General Equipment	8 Tables, 10 Chairs
Audio Visual Equipment	LCD Screen, PC, Data Projector (when room open), Screen, Whiteboard

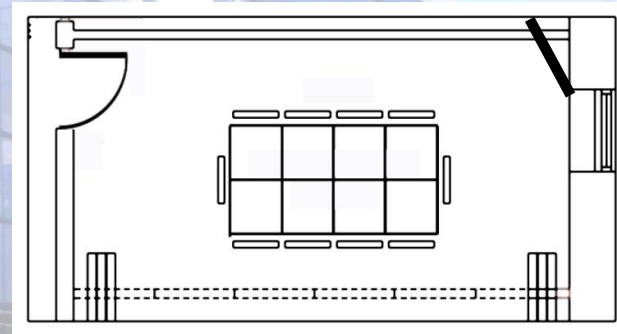

No food and drink. Please replace furniture.

1.28

Contact Details	Phone	email
Security Emergency number General enquiries	3333 2599	whitechapel-security@qmul.ac.uk
Audio Visual / Lecture Capture Technical assistance/faults Audio visual bookings	6550 8164	its-helpdesk@qmul.ac.uk avbookings@qmul.ac.uk
Maintenance / Cleaning / Porters	2580	estates-helpdesk@qmul.ac.uk
Room Bookings Room booking enquiries Events & Hospitality sales office	8163 8174	timetabling@qmul.ac.uk https://WebRoomBookings.qmul.ac.uk enquiries@qmhospitality.co.uk



Please note that the external prefix to all these numbers is 020-7882

The fire evacuation meeting point for this building is **Blizard Mews, Newark Street**

Room Details	Capacity - 10
General Equipment	10 Tables, 10 Chairs
Audio Visual Equipment	LCD Screen, PC, Data Projector (when room open), Screen, Whiteboard

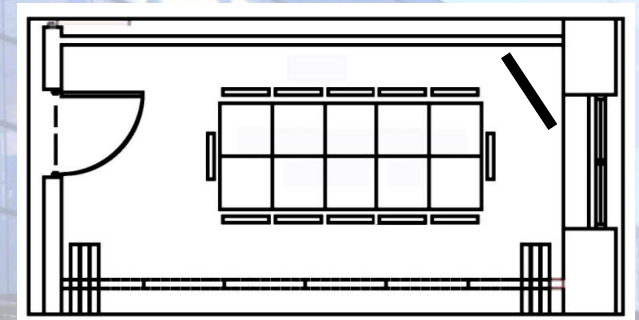

No food and drink. Please replace furniture.

1.28A

Contact Details	Phone	email
Security Emergency number General enquiries	3333 2599	whitechapel-security@qmul.ac.uk
Audio Visual / Lecture Capture Technical assistance/faults Audio visual bookings	6550 8164	lts-helpdesk@qmul.ac.uk avbookings@qmul.ac.uk
Maintenance / Cleaning / Porters	2580	estates-helpdesk@qmul.ac.uk
Room Bookings Room booking enquiries Events & Hospitality sales office	8163 8174	timetabling@qmul.ac.uk https://WebRoomBookings.qmul.ac.uk enquiries@qmhospitality.co.uk



Please note that the external prefix to all these numbers is 020-7882

The fire evacuation meeting point for this building is
Blizard Mews, Newark Street

Room Details	Capacity - 10
General Equipment	8 Tables, 10 Chairs
Audio Visual Equipment	LCD Screen, PC, Whiteboard

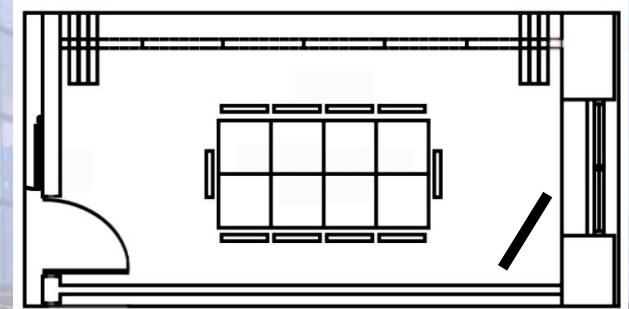

No food and drink. Please replace furniture.

1.29

Contact Details	Phone	email
Security Emergency number General enquiries	3333 2599	whitechapel-security@qmul.ac.uk
Audio Visual / Lecture Capture Technical assistance/faults Audio visual bookings	6550 8164	its-helpdesk@qmul.ac.uk avbookings@qmul.ac.uk
Maintenance / Cleaning / Porters	2580	estates-helpdesk@qmul.ac.uk
Room Bookings Room booking enquiries Events & Hospitality sales office	8163 8174	timetabling@qmul.ac.uk https://WebRoomBookings.qmul.ac.uk enquiries@qmhospitality.co.uk



Please note that the external prefix to all these numbers is 020-7882

The fire evacuation meeting point for this building is
Blizard Mews, Newark Street

Room Details	Capacity - 10
General Equipment	120 Fixed Seats, Teaching Desk
Audio Visual Equipment	LCD Screen, PC, Data Projector (when room open), Screen, Whiteboard

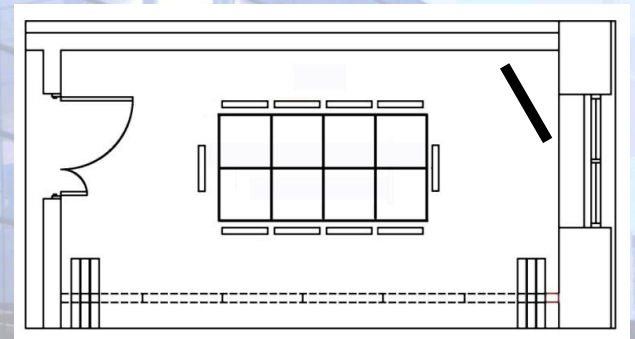

No food and drink. Please replace furniture.

1.29A

Contact Details	Phone	email
Security Emergency number General enquiries	3333 2599	whitechapel-security@qmul.ac.uk
Audio Visual / Lecture Capture Technical assistance/faults Audio visual bookings	6550 8164	its-helpdesk@qmul.ac.uk avbookings@qmul.ac.uk
Maintenance / Cleaning / Porters	2580	estates-helpdesk@qmul.ac.uk
Room Bookings Room booking enquiries Events & Hospitality sales office	8163 8174	timetabling@qmul.ac.uk https://WebRoomBookings.qmul.ac.uk enquiries@qmhospitality.co.uk



Please note that the external prefix to all these numbers is 020-7882

The fire evacuation meeting point for this building is
Blizard Mews, Newark Street

Room Details	Capacity - 10
General Equipment	8 Tables, 10 Chairs
Audio Visual Equipment	LCD Screen, PC, Whiteboard

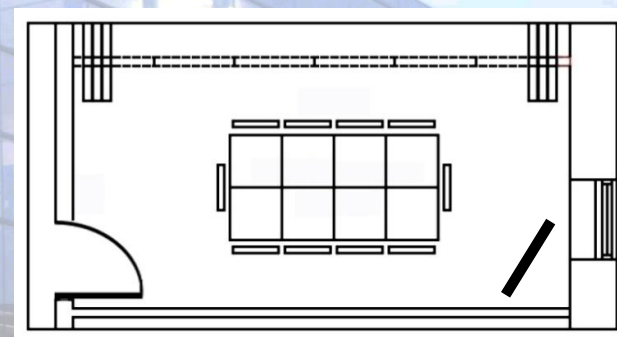

No food and drink. Please replace furniture.

1.30

Contact Details	Phone	email
Security Emergency number General enquiries	3333 2599	whitechapel-security@qmul.ac.uk
Audio Visual / Lecture Capture Technical assistance/faults Audio visual bookings	6550 8164	its-helpdesk@qmul.ac.uk avbookings@qmul.ac.uk
Maintenance / Cleaning / Porters	2580	estates-helpdesk@qmul.ac.uk
Room Bookings Room booking enquiries Events & Hospitality sales office	8163 8174	timetabling@qmul.ac.uk https://WebRoomBookings.qmul.ac.uk enquiries@qmhospitality.co.uk

Please note that the external prefix to all these numbers is 020-7882

The fire evacuation meeting point for this building is
Blizard Mews, Newark Street

Room Details	Capacity - 24
General Equipment	24 Tables, 24 Chairs
Audio Visual Equipment	Data Projector, Screen, Whiteboard

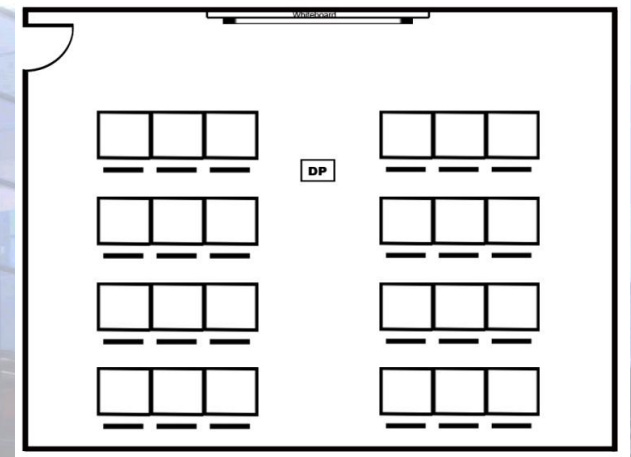

No food and drink. Please replace furniture.

1.32

Contact Details	Phone	email
Security Emergency number General enquiries	3333 2599	whitechapel-security@qmul.ac.uk
Audio Visual / Lecture Capture Technical assistance/faults Audio visual bookings	6550 8164	lts-helpdesk@qmul.ac.uk avbookings@qmul.ac.uk
Maintenance / Cleaning / Porters	2580	estates-helpdesk@qmul.ac.uk
Room Bookings Room booking enquiries Events & Hospitality sales office	8163 8174	timetabling@qmul.ac.uk https://WebRoomBookings.qmul.ac.uk enquiries@qmhospitality.co.uk



Please note that the external prefix to all these numbers is 020-7882

The fire evacuation meeting point for this building is **Blizard Mews, Newark Street**

Room Details	Capacity - 30
General Equipment	31 Tables, 31 Chairs
Audio Visual Equipment	Data Projector, Screen, Whiteboard

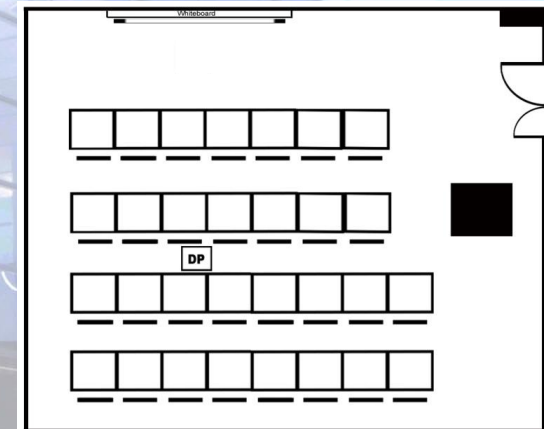

No food and drink. Please replace furniture.

2.07

Contact Details	Phone	email
Security Emergency number General enquiries	3333 2599	whitechapel-security@qmul.ac.uk
Audio Visual / Lecture Capture Technical assistance/faults Audio visual bookings	6550 8164	lts-helpdesk@qmul.ac.uk avbookings@qmul.ac.uk
Maintenance / Cleaning / Porters	2580	estates-helpdesk@qmul.ac.uk
Room Bookings Room booking enquiries Events & Hospitality sales office	8163 8174	timetabling@qmul.ac.uk https://WebRoomBookings.qmul.ac.uk enquiries@qmhospitality.co.uk



Please note that the external prefix to all these numbers is 020-7882

The fire evacuation meeting point for this building is
Blizard Mews, Newark Street

Room Details	Capacity - 16
General Equipment	6 Tables, 16 Chairs
Audio Visual Equipment	LCD Screen, PC, Flipchart, Screen, Whiteboard

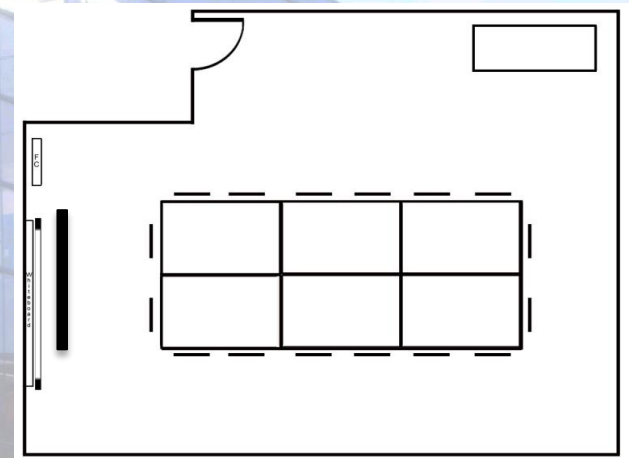

No food and drink. Please replace furniture.

2.35

Contact Details	Phone	email
Security Emergency number General enquiries	3333 2599	whitechapel-security@qmul.ac.uk
Audio Visual / Lecture Capture Technical assistance/faults Audio visual bookings	6550 8164	its-helpdesk@qmul.ac.uk avbookings@qmul.ac.uk
Maintenance / Cleaning / Porters	2580	estates-helpdesk@qmul.ac.uk
Room Bookings Room booking enquiries Events & Hospitality sales office	8163 8174	timetabling@qmul.ac.uk https://WebRoomBookings.qmul.ac.uk enquiries@qmhospitality.co.uk



Please note that the external prefix to all these numbers is 020-7882

The fire evacuation meeting point for this building is **Blizard Mews, Newark Street**

Room Details	Capacity - 18
General Equipment	18 Tables, 18 Chairs
Audio Visual Equipment	Data Projector, Screen, Whiteboard

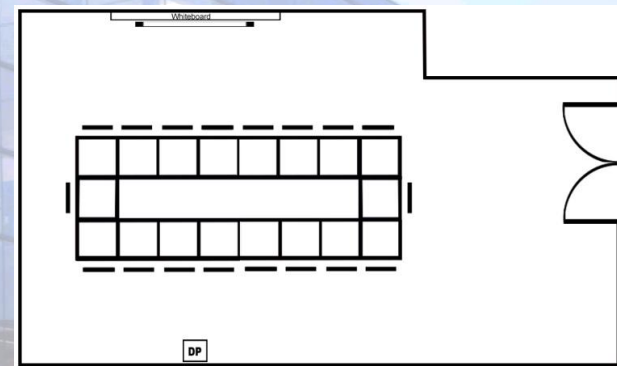

No food and drink. Please replace furniture.

2.36

Contact Details	Phone	email
Security Emergency number General enquiries	3333 2599	whitechapel-security@qmul.ac.uk
Audio Visual / Lecture Capture Technical assistance/faults Audio visual bookings	6550 8164	lts-helpdesk@qmul.ac.uk avbookings@qmul.ac.uk
Maintenance / Cleaning / Porters	2580	estates-helpdesk@qmul.ac.uk
Room Bookings Room booking enquiries Events & Hospitality sales office	8163 8174	timetabling@qmul.ac.uk https://WebRoomBookings.qmul.ac.uk enquiries@qmhospitality.co.uk



Please note that the external prefix to all these numbers is 020-7882

The fire evacuation meeting point for this building is
Blizard Mews, Newark Street

Room Details	Capacity - 30
General Equipment	30 Tables, 30 Chairs, Teaching Desk
Audio Visual Equipment	Data Projector, Screen, Whiteboard

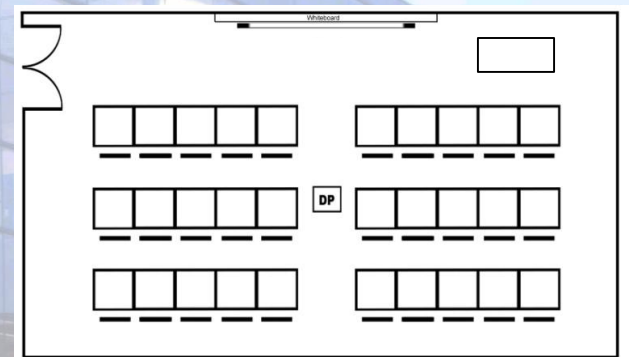

No food and drink. Please replace furniture.

2.39

Contact Details	Phone	email
Security Emergency number General enquiries	3333 2599	whitechapel-security@qmul.ac.uk
Audio Visual / Lecture Capture Technical assistance/faults Audio visual bookings	6550 8164	its-helpdesk@qmul.ac.uk avbookings@qmul.ac.uk
Maintenance / Cleaning / Porters	2580	estates-helpdesk@qmul.ac.uk
Room Bookings Room booking enquiries Events & Hospitality sales office	8163 8174	timetabling@qmul.ac.uk https://WebRoomBookings.qmul.ac.uk enquiries@qmhospitality.co.uk



Please note that the external prefix to all these numbers is 020-7882

The fire evacuation meeting point for this building is
Blizard Mews, Newark Street

Room Details	Capacity - 16
General Equipment	16 Tables, 16 Chairs
Audio Visual Equipment	LCD Screen, Screen, Whiteboard

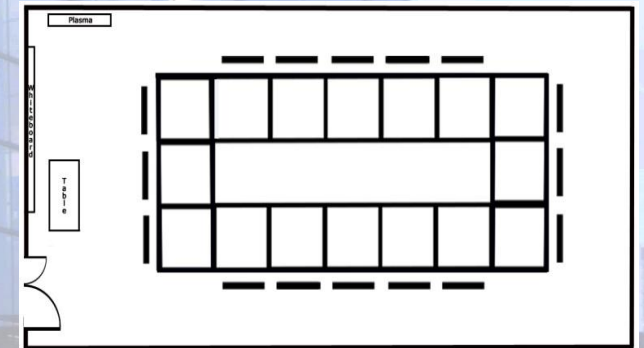

No food and drink. Please replace furniture.

2.44

Contact Details	Phone	email
Security Emergency number General enquiries	3333 2599	whitechapel-security@qmul.ac.uk
Audio Visual / Lecture Capture Technical assistance/faults Audio visual bookings	6550 8164	lts-helpdesk@qmul.ac.uk avbookings@qmul.ac.uk
Maintenance / Cleaning / Porters	2580	estates-helpdesk@qmul.ac.uk
Room Bookings Room booking enquiries Events & Hospitality sales office	8163 8174	timetabling@qmul.ac.uk https://WebRoomBookings.qmul.ac.uk enquiries@qmhospitality.co.uk



Please note that the external prefix to all these numbers is 020-7882

The fire evacuation meeting point for this building is
Blizard Mews, Newark Street

Room Details	Capacity - 10
General Equipment	8 Tables, 10 Chairs
Audio Visual Equipment	LCD Screen, Data Projector (when room open), PC, Screen, Whiteboard

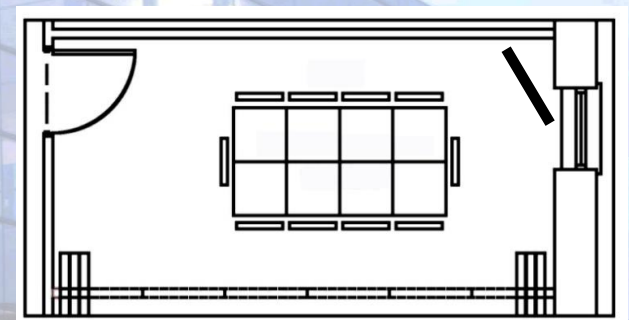

No food and drink. Please replace furniture.

2.44A

Contact Details	Phone	email
Security Emergency number General enquiries	3333 2599	whitechapel-security@qmul.ac.uk
Audio Visual / Lecture Capture Technical assistance/faults Audio visual bookings	6550 8164	its-helpdesk@qmul.ac.uk avbookings@qmul.ac.uk
Maintenance / Cleaning / Porters	2580	estates-helpdesk@qmul.ac.uk
Room Bookings Room booking enquiries Events & Hospitality sales office	8163 8174	timetabling@qmul.ac.uk https://WebRoomBookings.qmul.ac.uk enquiries@qmhospitality.co.uk



Please note that the external prefix to all these numbers is 020-7882

The fire evacuation meeting point for this building is
Blizard Mews, Newark Street

Room Details	Capacity - 12
General Equipment	10 Tables, 12 Chairs
Audio Visual Equipment	LCD Screen, PC, Whiteboard

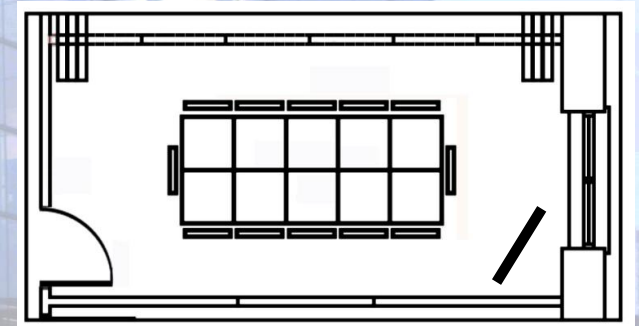

No food and drink. Please replace furniture.

2.48

Contact Details	Phone	email
Security Emergency number General enquiries	3333 2599	whitechapel-security@qmul.ac.uk
Audio Visual / Lecture Capture Technical assistance/faults Audio visual bookings	6550 8164	its-helpdesk@qmul.ac.uk avbookings@qmul.ac.uk
Maintenance / Cleaning / Porters	2580	estates-helpdesk@qmul.ac.uk
Room Bookings Room booking enquiries Events & Hospitality sales office	8163 8174	timetabling@qmul.ac.uk https://WebRoomBookings.qmul.ac.uk enquiries@qmhospitality.co.uk

Please note that the external prefix to all these numbers is 020-7882

The fire evacuation meeting point for this building is
Blizard Mews, Newark Street

Room Details	Capacity - 32
General Equipment	32 Tables, 32 Chairs
Audio Visual Equipment	Data Projector, Screen, Whiteboard

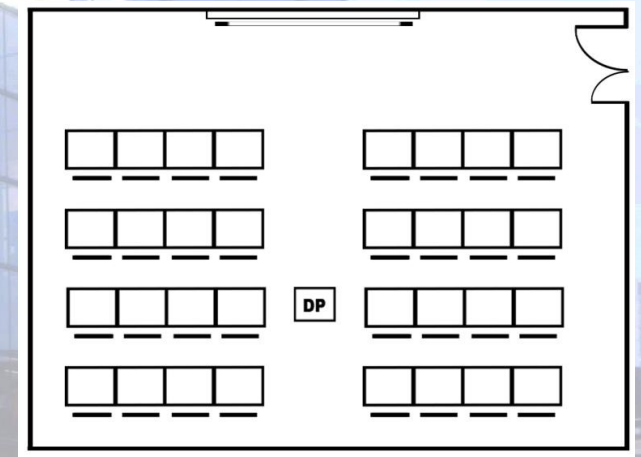

No food and drink. Please replace furniture.

3.03

Contact Details	Phone	email
Security Emergency number General enquiries	3333 2599	whitechapel-security@qmul.ac.uk
Audio Visual / Lecture Capture Technical assistance/faults Audio visual bookings	6550 8164	lts-helpdesk@qmul.ac.uk avbookings@qmul.ac.uk
Maintenance / Cleaning / Porters	2580	estates-helpdesk@qmul.ac.uk
Room Bookings Room booking enquiries Events & Hospitality sales office	8163 8174	timetabling@qmul.ac.uk https://WebRoomBookings.qmul.ac.uk enquiries@qmhospitality.co.uk

Please note that the external prefix to all these numbers is 020-7882

The fire evacuation meeting point for this building is
Blizard Mews, Newark Street

Room Details	Capacity - 8
General Equipment	8 Tables, 8 Chairs
Audio Visual Equipment	LCD Screen, Screen, Whiteboard

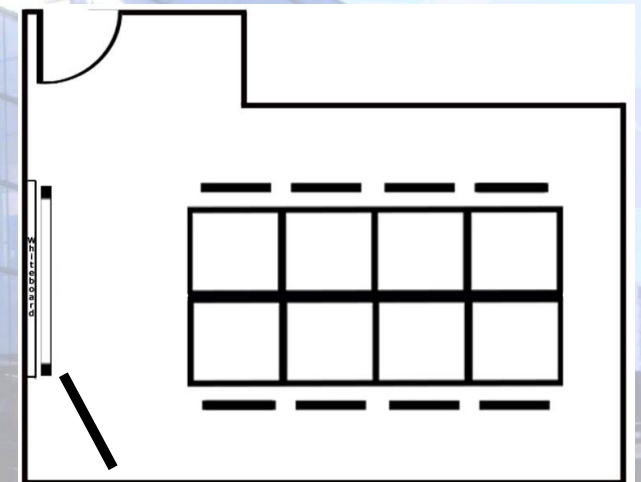

No food and drink. Please replace furniture.

3.04

Contact Details	Phone	email
Security Emergency number General enquiries	3333 2599	whitechapel-security@qmul.ac.uk
Audio Visual / Lecture Capture Technical assistance/faults Audio visual bookings	6550 8164	its-helpdesk@qmul.ac.uk avbookings@qmul.ac.uk
Maintenance / Cleaning / Porters	2580	estates-helpdesk@qmul.ac.uk
Room Bookings Room booking enquiries Events & Hospitality sales office	8163 8174	timetabling@qmul.ac.uk https://WebRoomBookings.qmul.ac.uk enquiries@qmhospitality.co.uk

Please note that the external prefix to all these numbers is 020-7882

The fire evacuation meeting point for this building is
Blizard Mews, Newark Street

Room Details	Capacity - 24
General Equipment	24 Tables, 24 Chairs
Audio Visual Equipment	Data Projector, Screen, Whiteboard

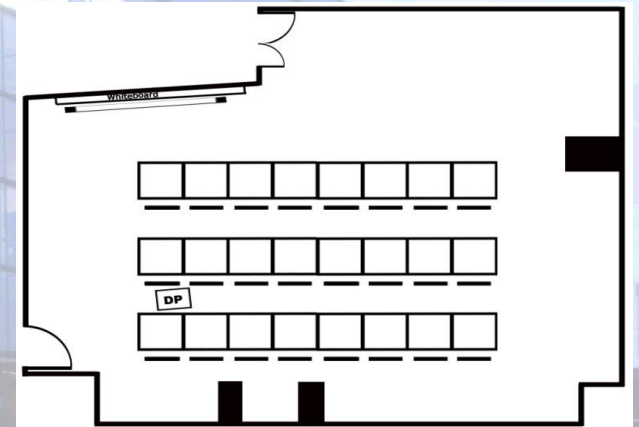

No food and drink. Please replace furniture.

3.05

Contact Details	Phone	email
Security Emergency number General enquiries	3333 2599	whitechapel-security@qmul.ac.uk
Audio Visual / Lecture Capture Technical assistance/faults Audio visual bookings	6550 8164	its-helpdesk@qmul.ac.uk avbookings@qmul.ac.uk
Maintenance / Cleaning / Porters	2580	estates-helpdesk@qmul.ac.uk
Room Bookings Room booking enquiries Events & Hospitality sales office	8163 8174	timetabling@qmul.ac.uk https://WebRoomBookings.qmul.ac.uk enquiries@qmhospitality.co.uk



Please note that the external prefix to all these numbers is 020-7882

The fire evacuation meeting point for this building is
Blizard Mews, Newark Street

Room Details	Capacity - 12
General Equipment	120 Fixed Seats, Teaching Desk
Audio Visual Equipment	LCD Screen, Data Projector (when room open), PC, Screen, Whiteboard

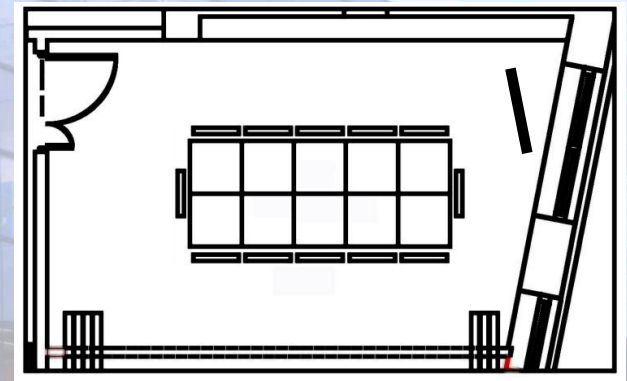

No food and drink. Please replace furniture.

3.05A

Contact Details	Phone	email
Security Emergency number General enquiries	3333 2599	whitechapel-security@qmul.ac.uk
Audio Visual / Lecture Capture Technical assistance/faults Audio visual bookings	6550 8164	lts-helpdesk@qmul.ac.uk avbookings@qmul.ac.uk
Maintenance / Cleaning / Porters	2580	estates-helpdesk@qmul.ac.uk
Room Bookings Room booking enquiries Events & Hospitality sales office	8163 8174	timetabling@qmul.ac.uk https://WebRoomBookings.qmul.ac.uk enquiries@qmhospitality.co.uk

Please note that the external prefix to all these numbers is 020-7882

The fire evacuation meeting point for this building is **Blizard Mews, Newark Street**

Room Details	Capacity - 12
General Equipment	10 Tables, 12 Chairs
Audio Visual Equipment	LCD Screen, PC, Whiteboard

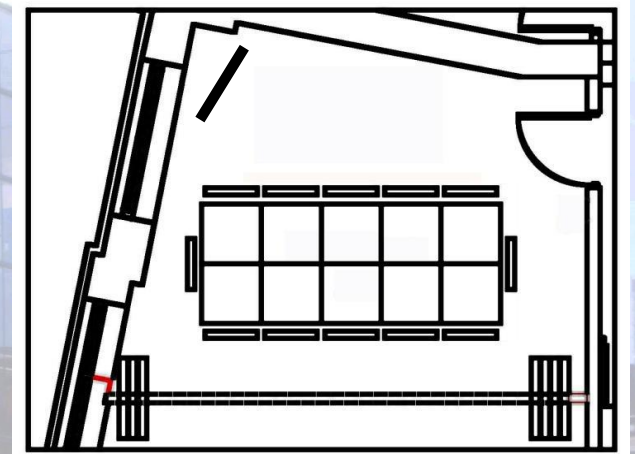

No food and drink. Please replace furniture.

3.06

Contact Details	Phone	email
Security Emergency number General enquiries	3333 2599	whitechapel-security@qmul.ac.uk
Audio Visual / Lecture Capture Technical assistance/faults Audio visual bookings	6550 8164	lts-helpdesk@qmul.ac.uk avbookings@qmul.ac.uk
Maintenance / Cleaning / Porters	2580	estates-helpdesk@qmul.ac.uk
Room Bookings Room booking enquiries Events & Hospitality sales office	8163 8174	timetabling@qmul.ac.uk https://WebRoomBookings.qmul.ac.uk enquiries@qmhospitality.co.uk



Please note that the external prefix to all these numbers is 020-7882

The fire evacuation meeting point for this building is
Blizard Mews, Newark Street

Room Details	Capacity - 50
General Equipment	50 Tables, 50 Chairs, Teaching Desk
Audio Visual Equipment	Data Projector, VHS, DVD, PA, PC, Visualiser, Screen, Whiteboard, Lecture Capture

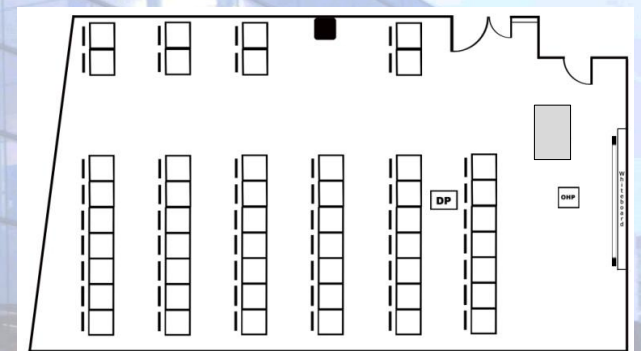

No food and drink. Please replace furniture.